



For Sure



SIGNATURE | DesignMount

USPs & benefits

SIGNATURE DesignMount | TVM 7655

INTEGRATED CABLE HOLDERS WITH COVER

Neatly store up to 4m cable out of sight on the back of the TV

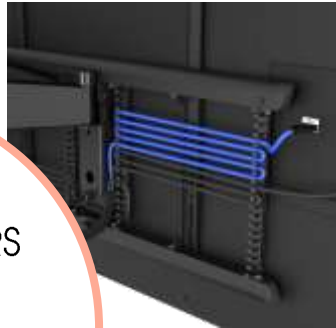

3D-LEVELING™: KEEP YOUR TV ALWAYS LEVEL

Slanting wall correction and precise after-installation leveling (horizontally and vertically)

SMOOTH ONE FINGER™ MOVEMENT

Thanks to coated bearings and precision steel shafts

FULLY INTEGRATED CABLE INLAY SYSTEM (CIS®)

Connect, protect and hide your cables, from wall to TV

SCREEN PROTECTION SYSTEM (SPS®)

Prevents your TV from bumping into the wall (for TVs up to 65 inch)

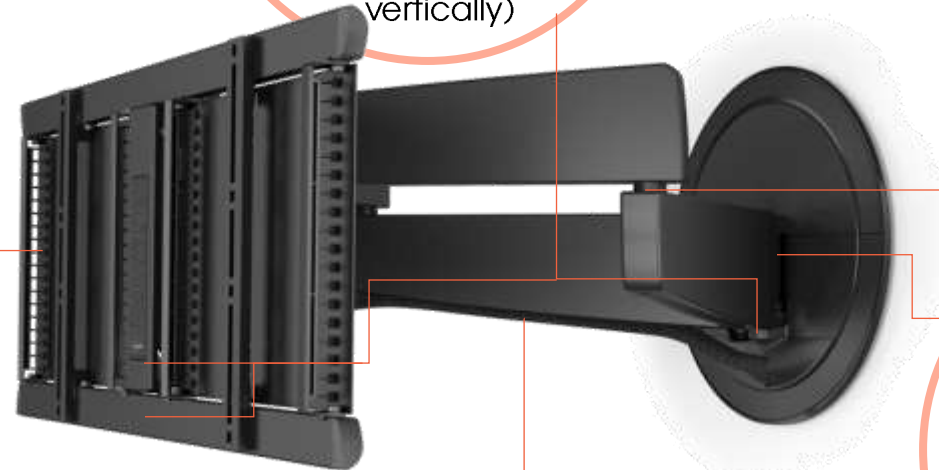

SIGNATURE | MotionMount

USPs & benefits



SIGNATURE MotionMount | TVM 7675



INTEGRATED CABLE HOLDERS WITH COVER

Neatly store up to 4m cable out of sight on the back of the TV



FULLY INTEGRATED CABLE INLAY SYSTEM (CIS®)

Connect, protect and hide your cables, from wall to TV



3D-LEVELING™: KEEP YOUR TV ALWAYS LEVEL

Slanting wall correction and precise after-installation leveling (horizontally and vertically)



ELECTRONIC SCREEN PROTECTION SYSTEM (ESPS®)

Prevents your TV from bumping into the wall

SIGNATURE MotionMount | TVM 7675 (cont.)

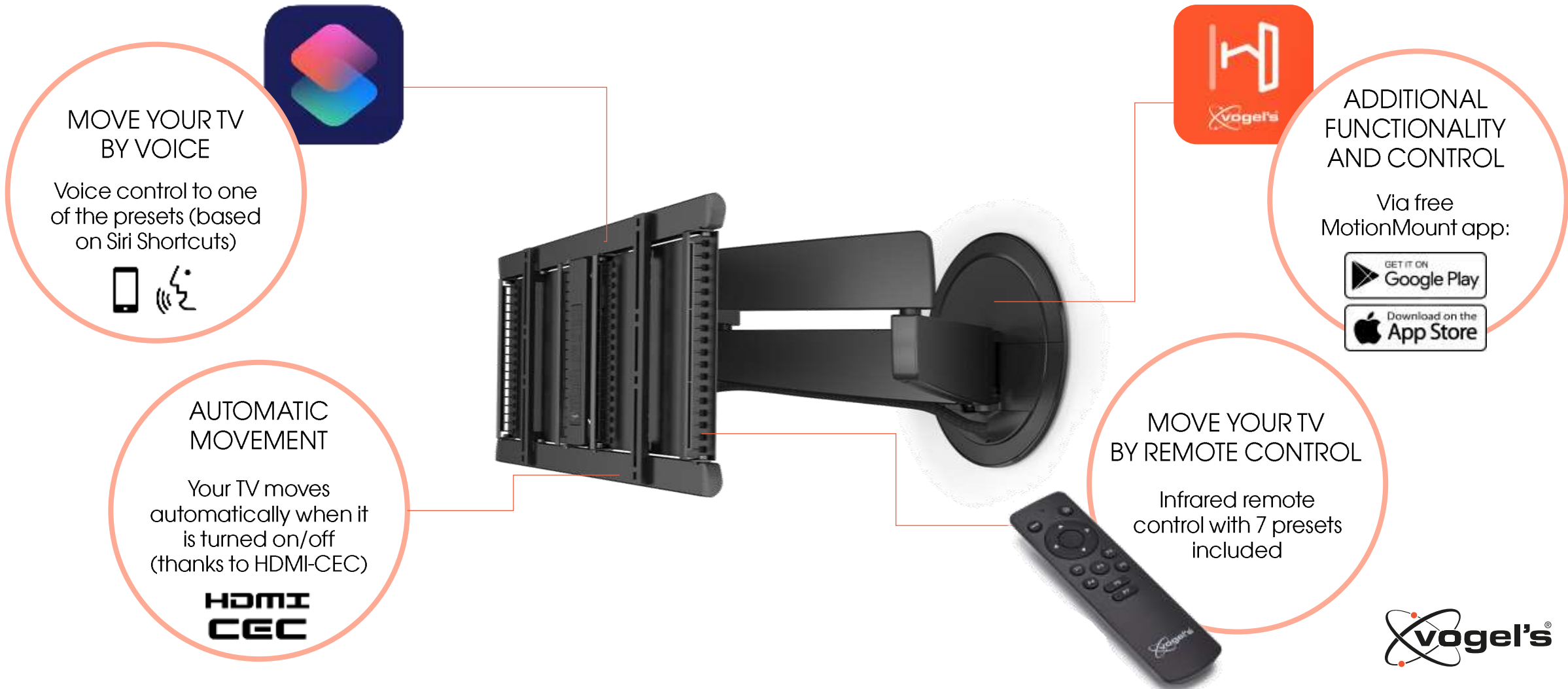

SIGNATURE MotionMount | TVM 7675 PRO





SIGNATURE | MotionMount

In detail...

Optimal compatibility guaranteed: all necessary connectivity included



auto-ranging
global DC adapter



infra red remote control +
infra red receiver



2m HDMI cable

All connectivity integrated in wall cover

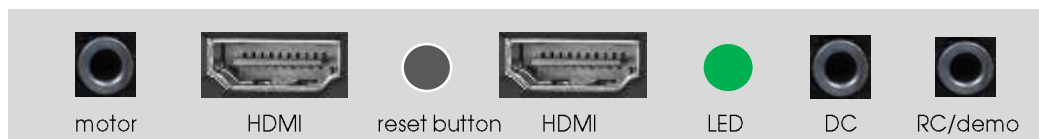
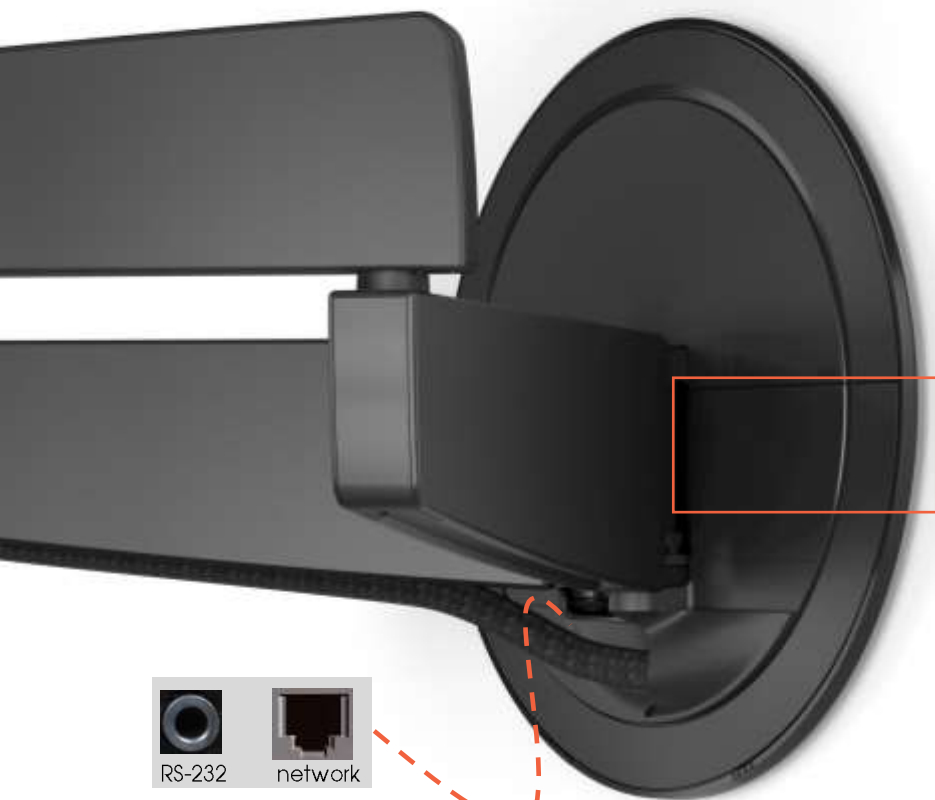

Ultimate cable management: 2 fully integrated installation options

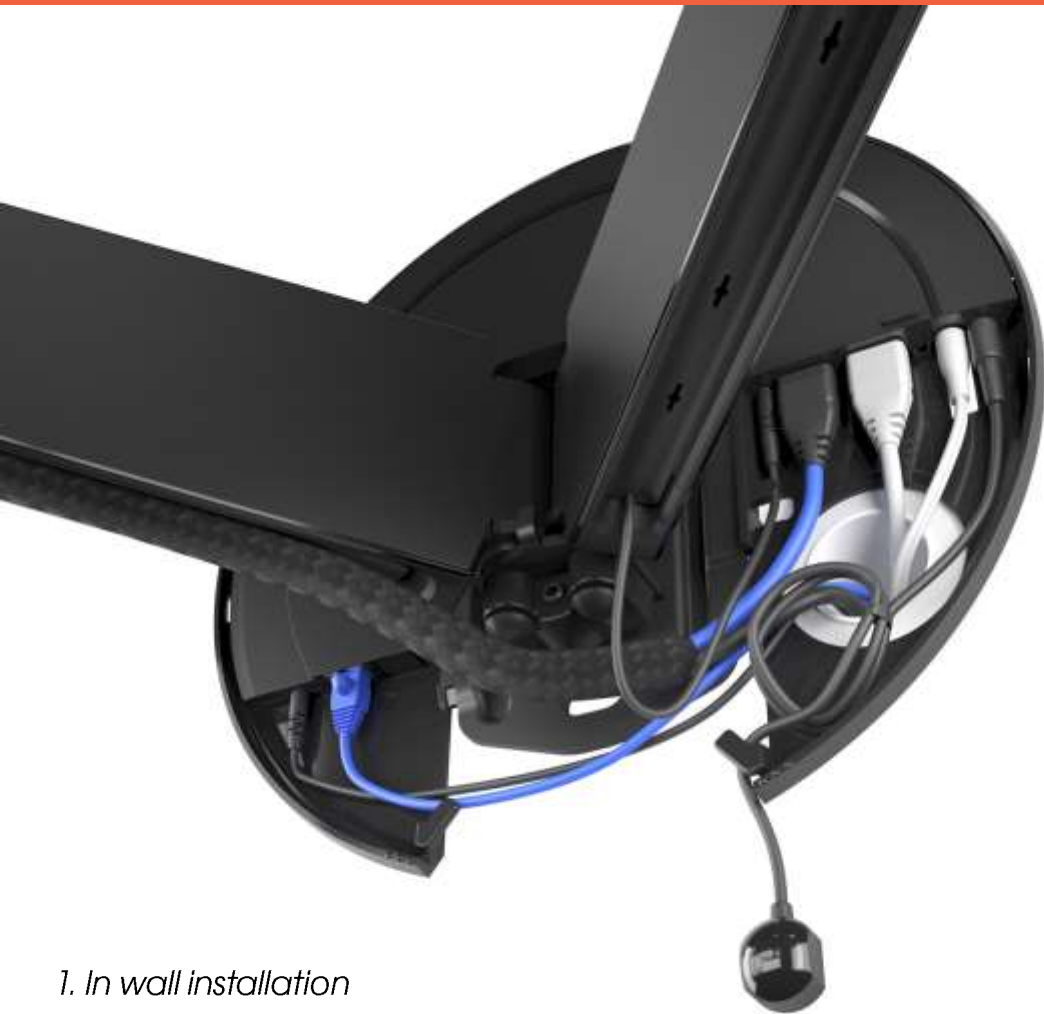

1. In wall installation



*2. Seamless fit installation
in combination with
high quality aluminium
cable cover (TVA 7000)*

Ultimate cable management | All cables out of sight, from TV to floor!

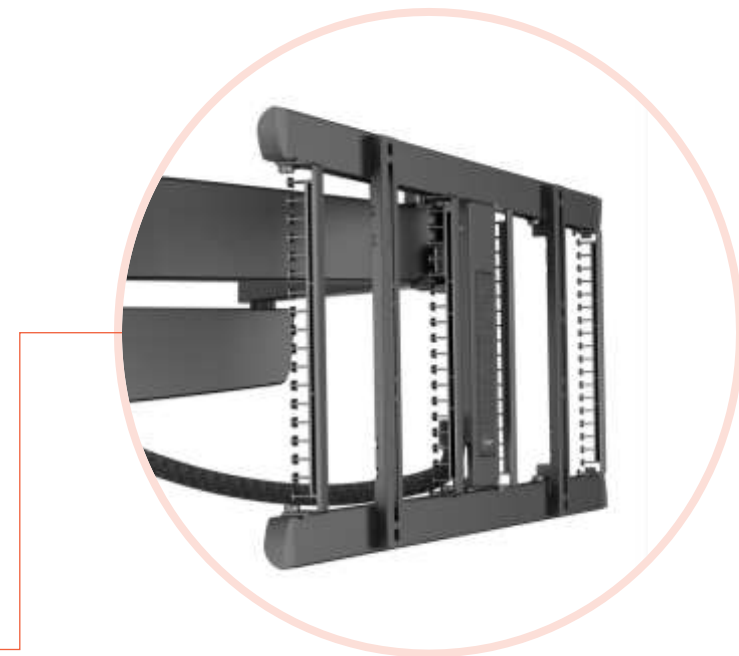

Exploded view | Serviceability of electronics

Easy exchange of electronics

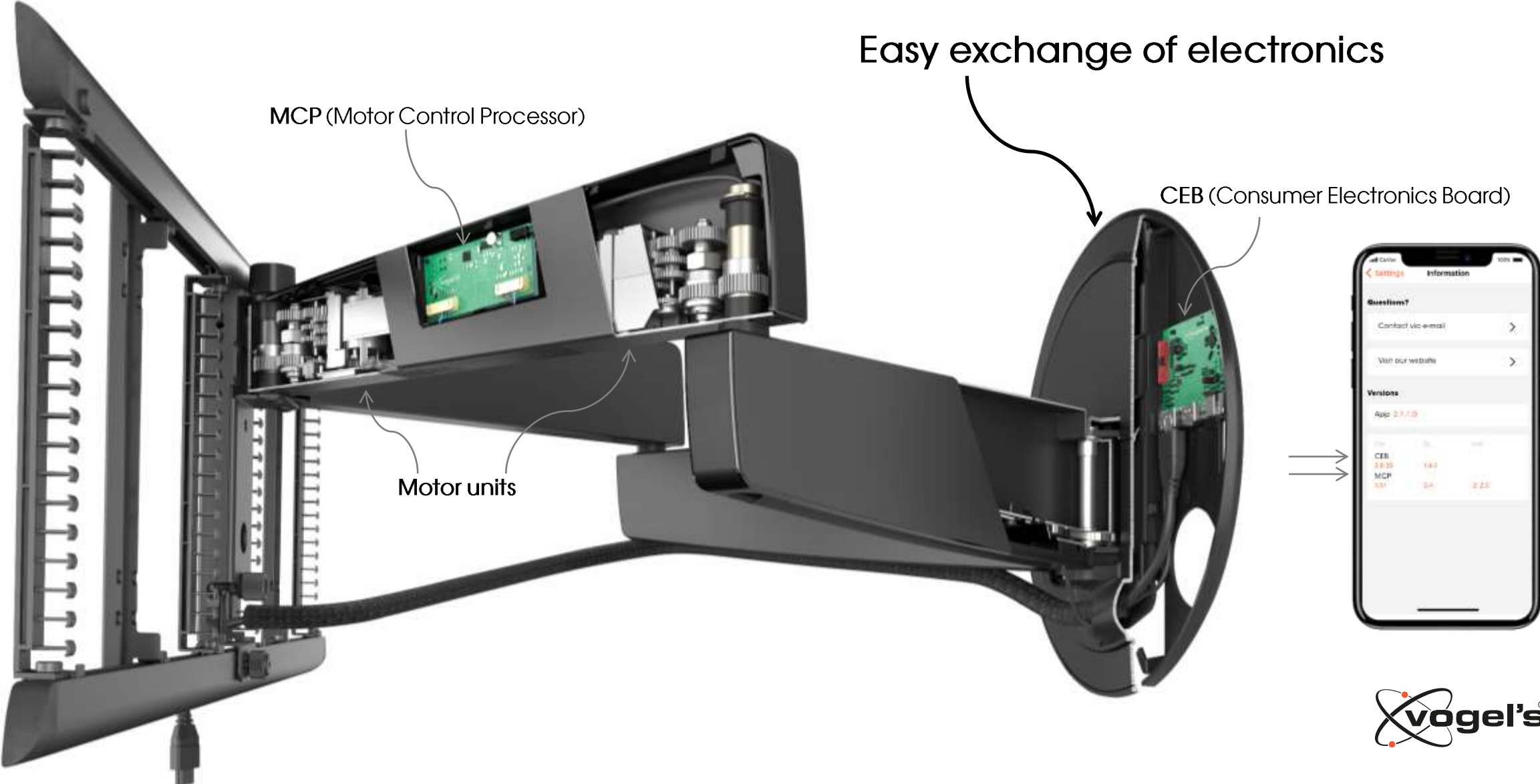



MotionMount

Application including dark mode

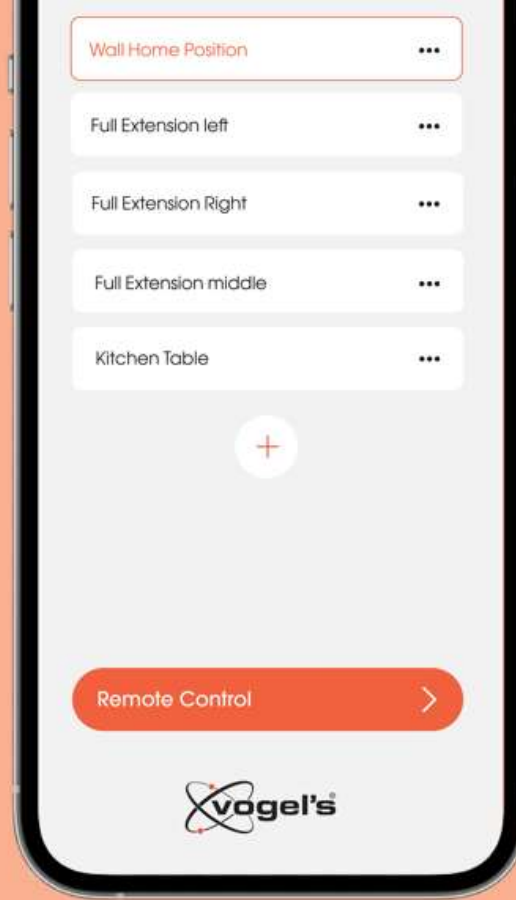

Programm

Create an
personalised p
remo

Remote control

Reach every desired position
with the remote control

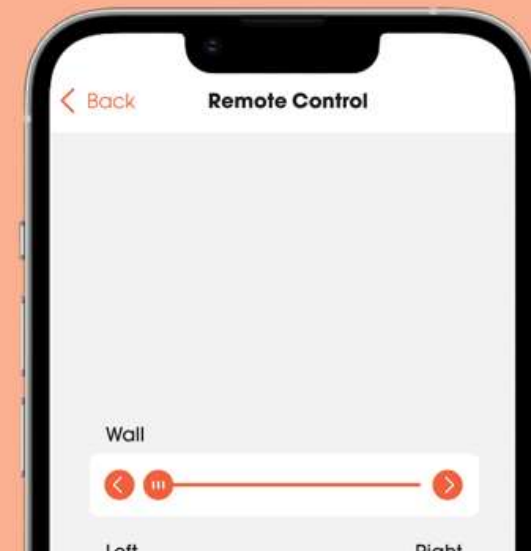

MotionMount control

Control options MotionMount

1. **AUTOMATIC Movement**

Default your TV moves to last position or to your favorite position when switching on your TV. TV will return to wall position when switching off the TV (triggered by HDMI-CEC)

2. **Voice control**

Move your TV to one of the presets by voice (based on Siri Shortcuts – Apple only)

3. **MotionMount App (iOS / Android)**

For onboarding, moving your TV to a position, to store presets and some more functionality

4. **Remote control (infrared included)**

For moving your TV to a position and to store presets



1. AUTOMATIC Movement

- By default, your TV moves to the last position or to your favorite position when switching on your TV. When switching off the TV, it returns to wall position (triggered by HDMI-CEC)
- Connect MotionMount with TV by means of HDMI cable:
 - In case of TV set with HDMI connectors at the back of the TV: use the by packed 2m HDMI cable
 - In case of TV set with 'Connect box' (like the Samsung One Connect Box): Use the additional 4,5m HDMI cable which can be ordered at Vogel's (adaptor kit 999985)
- Make sure HDMI-CEC is switched on in the settings menu of your TV.

Note that HDMI-CEC feature naming is different per TV brand:

- | | |
|---------------------------------|---|
| ▪ Samsung: AnyNet+ | ▪ Phillips: EasyLink |
| ▪ Sharp: Aquos Link | ▪ JVC: EZ-Sync |
| ▪ Sony: BRAVIA Link/BRAVIA Sync | ▪ Panasonic: HDAVI Control/EZ-Sync/VIERA Link |
| ▪ Toshiba: CE-Link/Regza Link | ▪ Mitsubishi: Netcommand |
| ▪ LG: SimpLink | |
| ▪ Loewe: Digital Link HD | |



2. Voice control

- Move your TV to one of the presets by voice (based on Siri Shortcuts – Apple only)

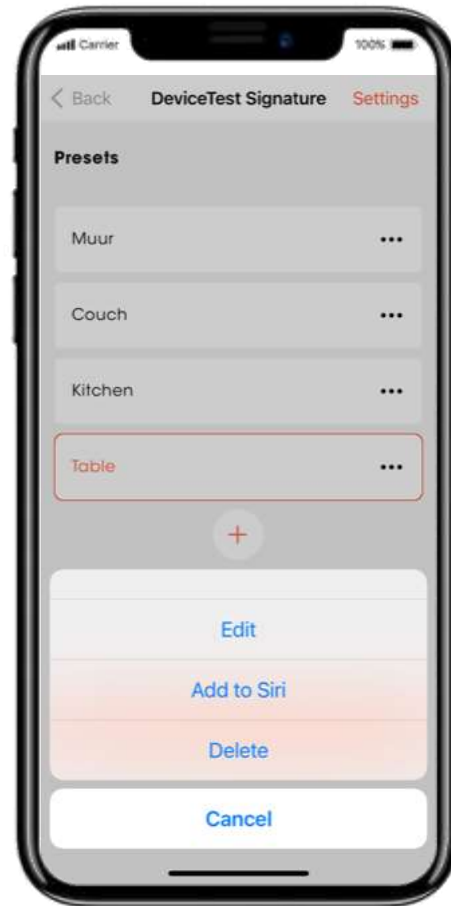

3. MotionMount App

- For onboarding, moving your TV to a position, to store presets and some more functionality
- Dark mode included
- Available in 8 languages
English, Dutch, German, French, Spanish, Portuguese, Danish, Simplified Chinese
- MotionMount is equipped with Bluetooth 5.0
- Free app available in App Store (iOS) and Google Play (Android)
Device hardware / OS-software requirements *:
 - Apple iOS 13 and newer / iPhone 6S and newer
 - Apple iPadOS 13 and newer / iPad Pro, iPad Air 2 and newer, iPad mini 2019, iPad mini 4, 9.7-inch iPad 2017 and newer
 - Android OS 9.0 and newer

*) Note: Only the latest iOS and Android OS versions are actively supported and tested by Vogel's

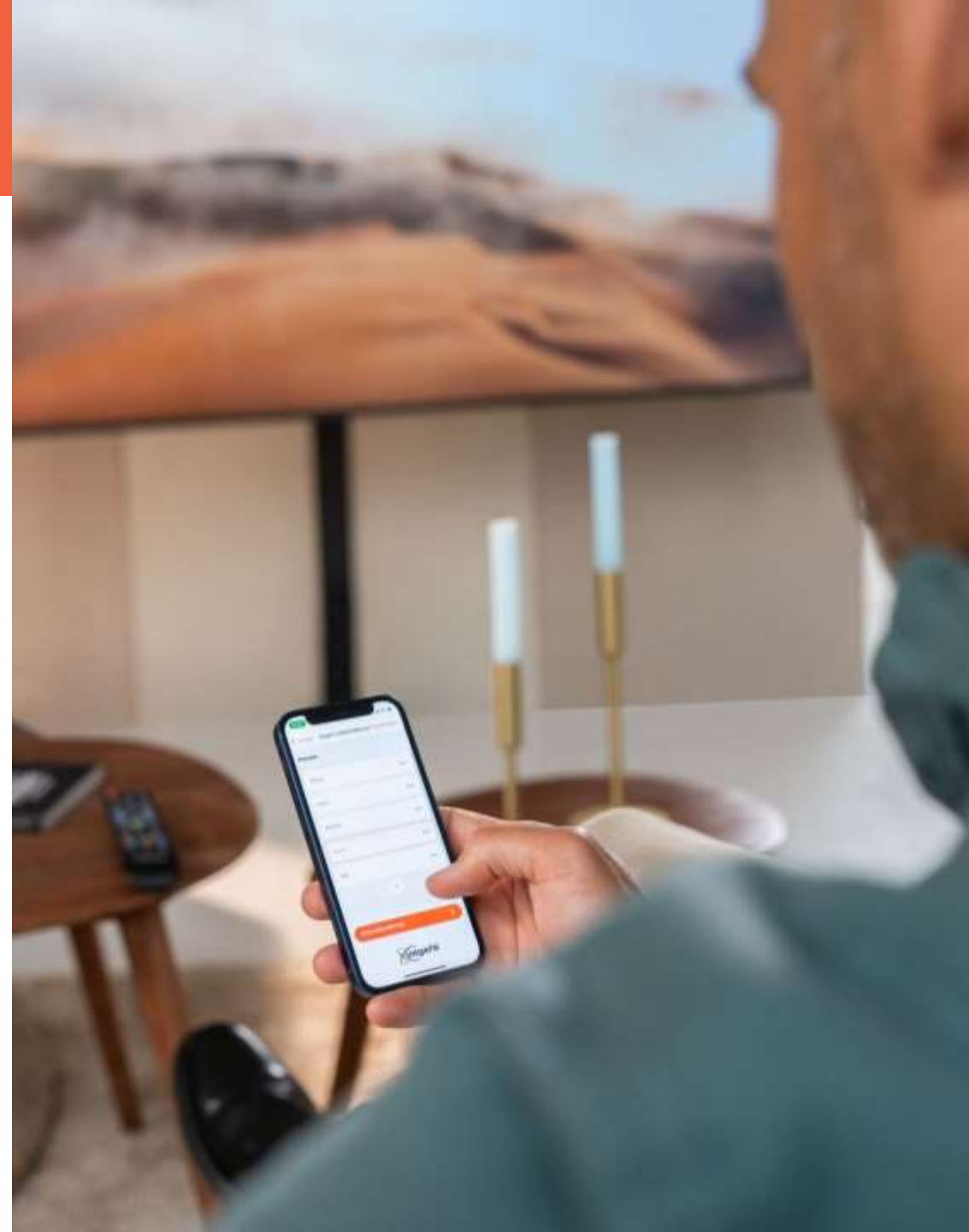

3. MotionMount App

Onboarding



Control



Settings



Security



Information

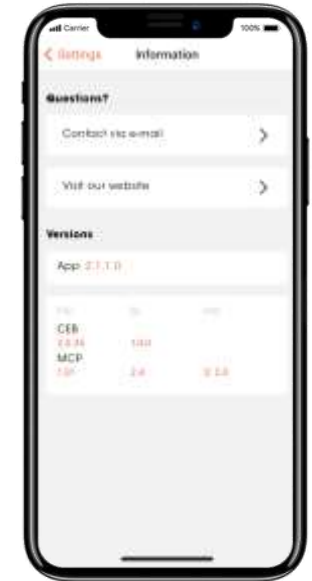

4. Infrared remote control

- To position your TV and to store presets
- A position can be stored by pushing one of the 7 preset buttons (P1 – P7) for at least 5 seconds
 - Presets will also become visible in MotionMount App
 - Presets can also be stored via the MotionMount App
- Connect the infrared receiver ('infrared eye') to the mini-jack connector at the right side (in the wall plate of the MotionMount)
- Position the infrared receiver in such a way that remote control signals can reach the receiver (direct and/or by reflections)



Controlling the TVM 7675 PRO MotionMount

- RS-232
- Ethernet protocol (TCP / IP)
- System integrators / Control system drivers under development:
 - Control4
 - Crestron
 - Crestron Home
- Home Assistant (open source platform)



*example only
(RS-232 3,5mm jack to USB cable)*

	A	B	C	D	E	F	G	H	I	J	K	L	M	N	O
1	Input	Command													
2		Left		Right		Forward		Backward		Stop Motion	Preset		Demo	Reset Network settings	Reset to Factory Settings
3		Stepped	Continuous	Stepped	Continuous	Stepped	Continuous	Stepped	Continuous		Call	Store			
4	App	x		x		x		x		x	x	x			
5	IR	Short tap	Long tap	Short tap	Long tap	Short tap	Long tap	Short tap	Long tap	Long tap release	Short Tap	Long Tap	x		
6	Siri Shortcuts	x		x		x		x			x				
7	HomeKit	x		x		x		x			x				
8	Cl	x		x		x		x		x	x	x			
9	Loewe		x		x		x		x	x					
10	Demo Button												x		
11	Reset Button													x	x



HASSLE FREE INSTALLATION

Easy mounting guaranteed
for everyone

Hassle free installation guaranteed

Marker for
DrillRight™ App

Interface cover
plate packed in
Inlay card

Components neatly organized in
eco-friendly paper pulp compartments



Hassle free installation guaranteed

Paper pulp tray

Mounting material
included in paper
bags

Quick starter guide



Drilling template



Hassle free installation | Step by step Quick Installation Guide

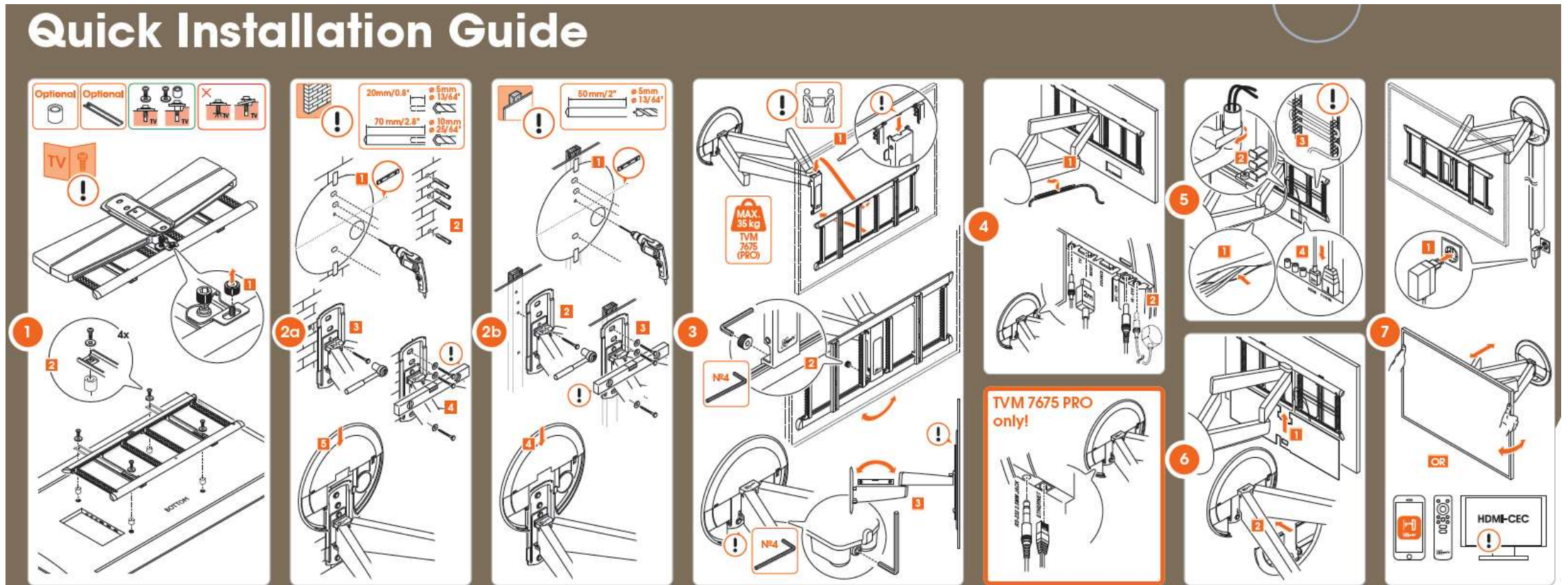

For more detailed information, check full online manual via QR code

Hassle free installation | Drilling template

- Drilling template incorporated in the box (Inlay card)
 - Pre-punched drill holes
 - Pre-punched cable entry hole
 - Mounting of wall bracket in combination with TVA 7000 Cable cover accessory taken into account

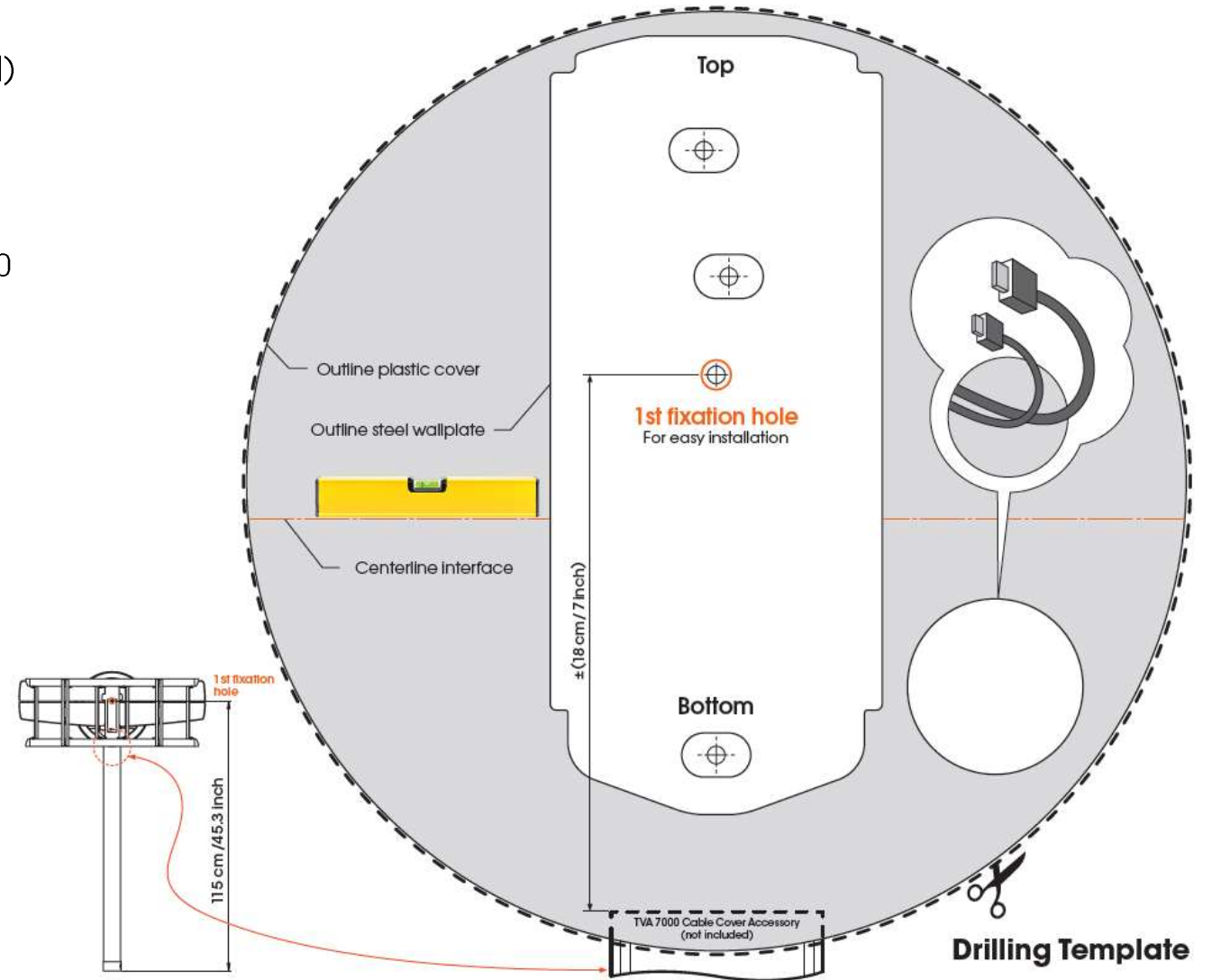

DrillRight™ app: Our unique AR mounting app

- Vogel's **DrillRight™ app***: mark the first drilling hole



- Innovative app based on Augmented Reality in order to assist in defining the perfect spot for your TV.
- SIGNATURE products available in app from **October 2022**



Hassle free installation | A detailed online manual

- Extensive, full manual online (per language):
 - Extensive instructions (per wall type)
 - Installation video
 - Tips & tricks
 - Apps (MotionMount and/or DrillRight AR)
 - Guarantee terms
 - FAQs & Troubleshooter
- Always up to date
- Printable PDF available
- <https://manuals.vogels.com>

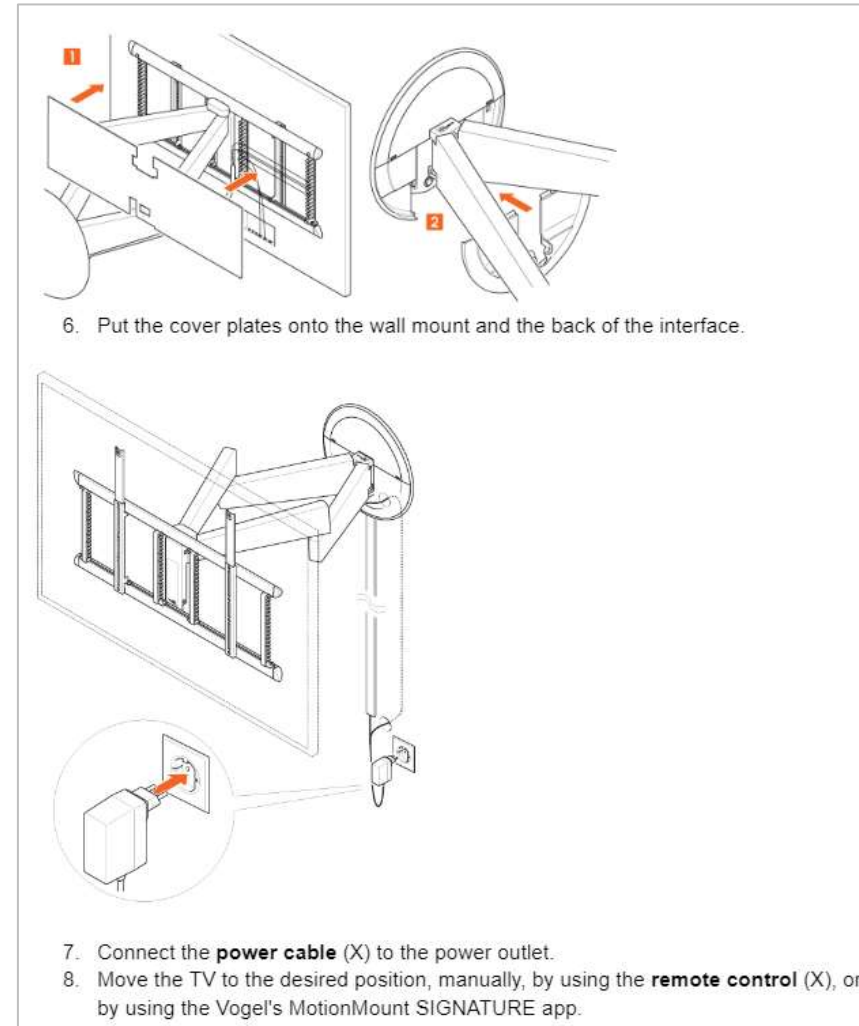

Example of online manual



VOGEL'S ACCESSORIES & KITS

Maximize your (online) cross-sell
opportunities

Upcoming new accessories: Cable cover TVA 7000

- Seamless fit with SIGNATURE wall mounts
- High quality aluminium cable cover
- 2 end caps included
- Up to 6 cables (5x Ø 7,5 mm, 1x Ø 9 mm)
- Length: 95 cm
- Packaging with Eurolock
- Article numbers:
 - Black: 6870000
 - White: 6870001

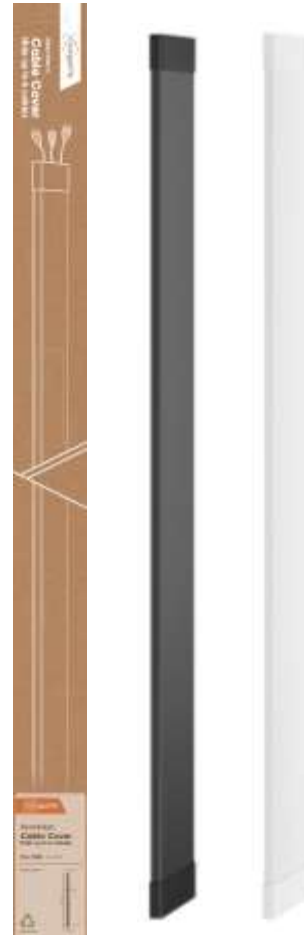

MotionMount adaptor kits / service accessories

Bluetooth remote control

- article number: 999965
- EAN: 8712285351280
- € 24,99



 Bluetooth

4,5 m HDMI cable

(connecting 'One Connect Box' TVs with the MotionMount)

- article number: 999985
- EAN: 8712285364006
- € 9,99



 vogel's®

Bluetooth remote control

- Optional: Available in Vogel's Webshop (€ 24,99)
- For moving your TV to a position and to store presets
 - Presets will also become visible in MotionMount App
 - Presets can also be stored via the MotionMount App
 - A position can be stored by pushing one of the 7 preset buttons (P1 – P7) for at least 5 seconds
- *Important: MotionMount name in this case must be the default (ex factory) name: **Vogel's MotionMount***





Upcoming additional accessories: Universal stud adapter TVA 6950

- Suitable for all Vogel's Full-Motion(+) TV wall mounts:
QUICK, COMFORT, ELITE, SIGNATURE Series
- Stud distances: 16, 20 and 24 inch, 450 and 600 mm
- Article number: 6869500

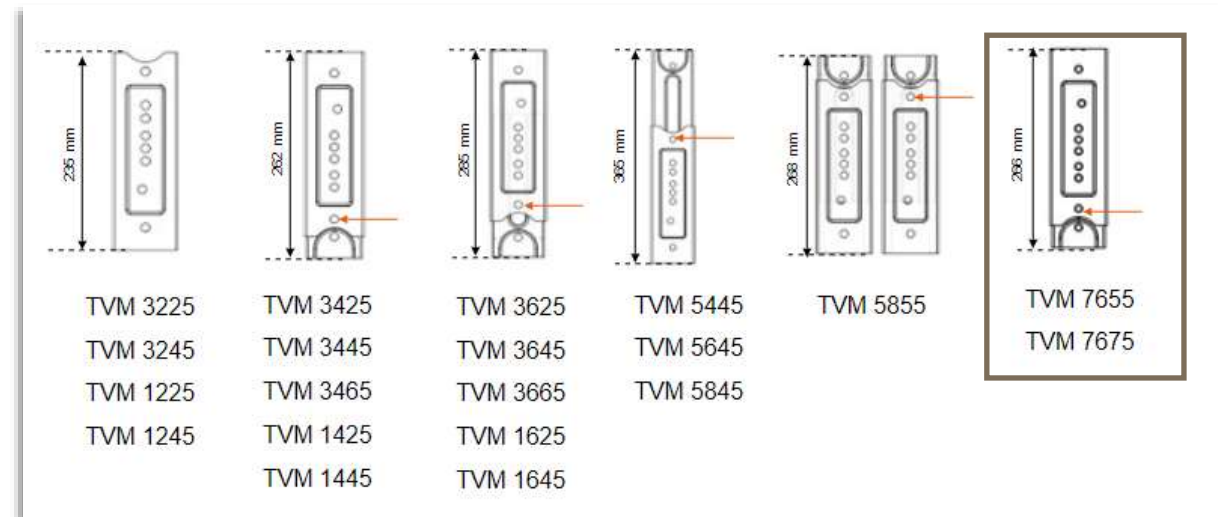

Remark: extra kit (strip) required for TVM 5855 (article number 999950)





ANNEX

- Detailed product specifications
- Price positioning
- Logistics information
- Spare parts overview
- Signature goods flow
- CE label MotionMount (PRO)
- CE Declaration of Conformity MotionMount (PRO)
- Marketing material collections Brand Portal
- DEMOS @ Vogel's Headquarters

SIGNATURE Product Line-up in detail

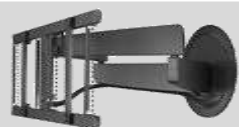
Functionality		Type number	Screen sizes	Max load	VESA	Distance from wall	Extends up to
FORWARD MOTION		TVM 7655	40 – 77 inch	35 kg	600 x 400	77 mm	72 cm
MOTORIZED		TVM 7675 (PRO)	40 – 77 inch	35 kg	600 x 400	77 mm	72 cm

Specifications DesignMount | TVM 7655

- **Seamless fit with any premium (OLED/QLED) TV**
 - Screen size range: 40 – 77 inch / 102 – 196 cm
 - Max load: 35 kg / 77 lbs
 - Max VESA: 600 x 400 (w x h)
- **Optimal flexibility and convenience**
 - Extends up to / distance (from the wall): 72 cm / 77 mm
 - 3D-Leveling™, including slanting wall correction
- **Enjoy a premium user experience**
 - Elegant design and premium construction
 - Smooth OneFinger™ Movement
 - SPS® Screen Protection System (up to 65 inch TVs)
 - TÜV NORD certified (tested up to 3x times max weight)
 - 15 years guarantee
- **Hide all your cables out of sight**
 - Fully integrated Cable Inlay System (CIS®)
 - Integrated cable holders with cover, hiding up to 4 m cable

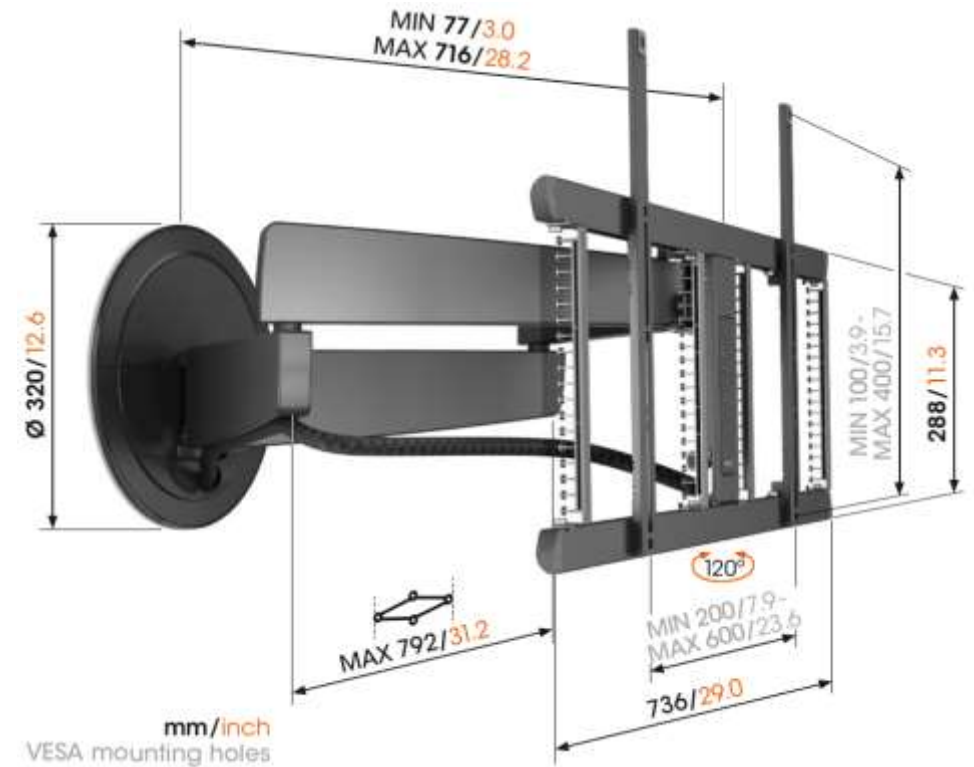

Specifications MotionMount | TVM 7675

- **Seamless fit with any premium (OLED/QLED) TV**
 - Screen size range: 40 – 77 inch / 102 – 196 cm
 - Max load: 35 kg / 77 lbs
 - Max VESA: 600 x 400 (w x h)
- **Optimal flexibility and convenience**
 - Extends up to / distance (from the wall): 72 cm / 77 mm
 - 3D-Leveling™, including slanting wall correction
- **Enjoy a premium user experience**
 - AUTOMATIC Movement when TV is switched on/off (HDMI-CEC)
 - Siri voice control (Siri Shortcuts)
 - App control with extensive functionality
 - Infrared remote control included
 - 7 programmable presets
 - ESPS® Electronic Screen Protection System
 - TÜV NORD certified (tested up to 3x times max weight)
 - 15 years guarantee (2 years on electronics)
- **Hide all your cables out of sight**
 - Fully integrated Cable Inlay System (CIS®)
 - Integrated cable holders with cover, hiding up to 4 m cable

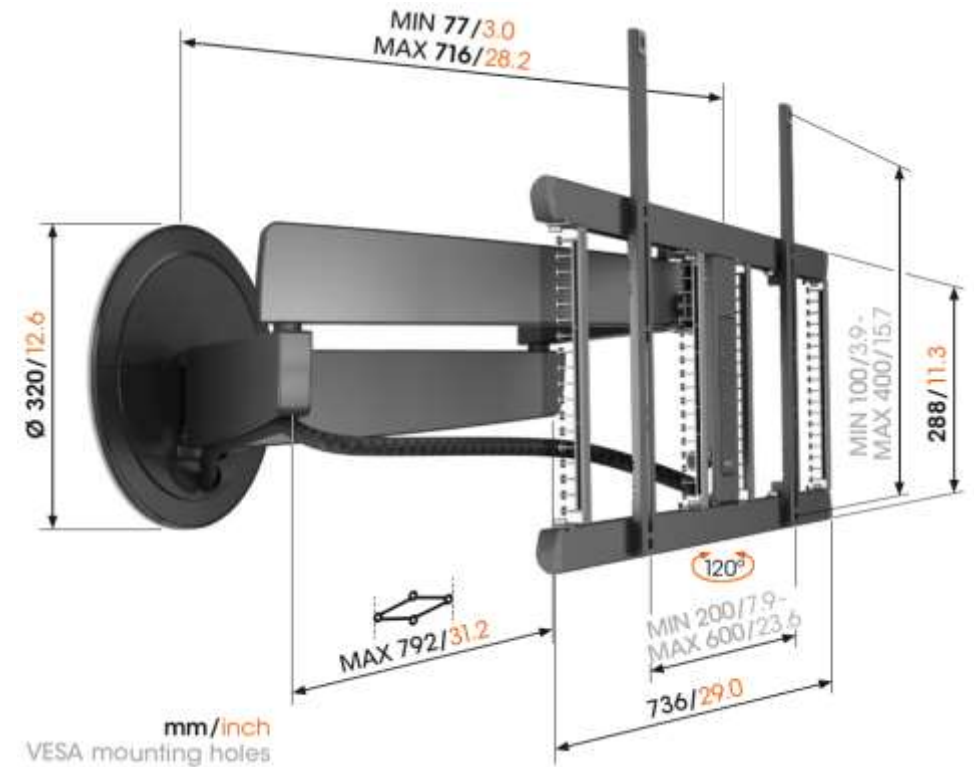

SIGNATURE
MotionMount App



Specifications MotionMount | TVM 7675 PRO

- **Seamless fit with any premium (OLED/QLED) TV**
 - Screen size range: 40 – 77 inch / 102 – 196 cm
 - Max load: 35 kg / 77 lbs (TüV3)
 - Max VESA: 600 x 400 (w x h)
- **Optimal flexibility and convenience**
 - Extends up to / distance (from the wall): 72 cm / 77 mm
 - 3D-Leveling™, including slanting wall correction
 - TÜV NORD certified (tested up to 3x times max weight)
 - 15 years guarantee (2 years on electronics)
- **Enjoy a premium user experience**
 - Ethernet and RS-232 control
 - AUTOMATIC Movement when TV is switched on/off (HDMI-CEC)
 - Siri voice control (Siri Shortcuts)
 - App control with extensive functionality
 - Infrared remote control included
 - 7 programmable presets
 - ESPS® Electronic Screen Protection System
- **Hide all your cables out of sight**
 - Fully integrated Cable Inlay System (CIS®)
 - Integrated cable holders with cover, hiding up to 4 m cable

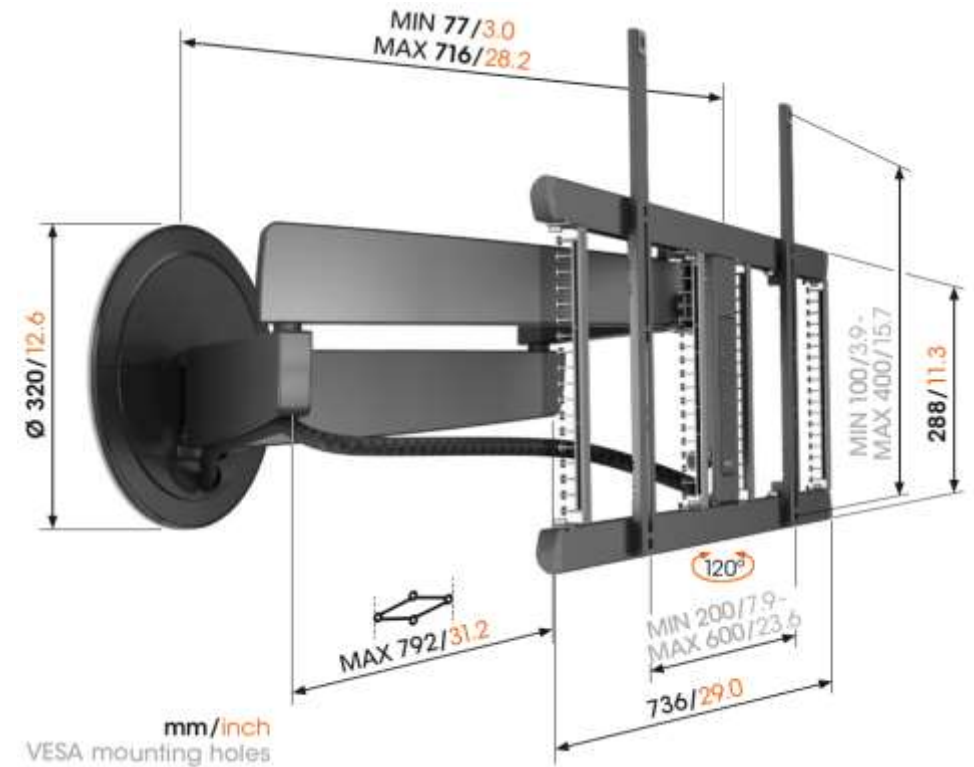

SIGNATURE
MotionMount App



The Maximum Turning Angle of Your TV *

TV size (inch)	DesignMount TVM 7655	MotionMount TVM 7675 (PRO)
40	120°	120°
55	120°	120°
65	120°	120°
75	100°	100°
77	95°	95°

*) Maximum turning angles are for orientation purposes only and are based on average TV width per inch size

